

FAG

**3206-BD-XL**

Angular contact ball bearing

Schaeffler ID:  
0709298660000Angular contact ball bearing 32..-BD-XL,  
double row, X-life, steel sheet metal cage

X-life

## Technical information

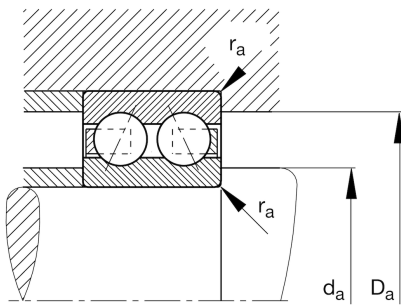
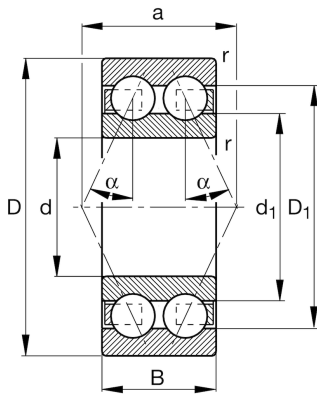

## Main Dimensions &amp; Performance Data

d	30 mm	Bore diameter
D	62 mm	Outside diameter
B	23,8 mm	Width
$C_r$	31.000 N	Basic dynamic load rating, radial
$C_{0r}$	22.200 N	Basic static load rating, radial
$C_{ur}$	1.540 N	Fatigue load limit, radial
$n_G$	11.900 1/min	Limiting speed
$n_{gr}$	11.100 1/min	Reference speed
	0,286 kg	Weight

## Dimensions

$r_{min}$	1 mm	Minimum chamfer dimension
$D_1$	53,3 mm	Shoulder diameter outer ring
$d_1$	42,2 mm	Shoulder diameter inner ring
a	36,4 mm	Distance between the apexes of the pressure cones
$\alpha$	30 °	Contact angle

## Mounting dimensions

$d_{a min}$	35,6 mm	Minimum diameter shaft shoulder
$D_{a max}$	56,4 mm	Maximum diameter of housing shoulder
$r_{a max}$	1 mm	Maximum fillet radius

## Temperature range

$T_{min}$	-30 °C	Operating temperature min.
$T_{max}$	120 °C	Operating temperature max.